

---

**LED Profile light**



**LED Profile light**

---

Operating Manual

---



# LED Profile light

## 9.Function

### DMX Mode

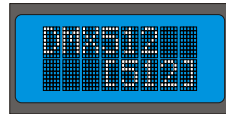
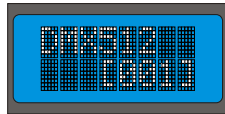
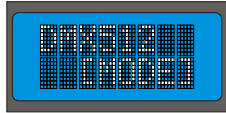

DMX Address Allocation: 001-512

### DMX 3 Channels

CH	1	2	3
%	DIMMING	STROBE	Dim4
100%	ALL DIMMING	STROBE	255
75%			192
50%			128
25%			64
0%			0
		10 Invalid	0

### Dimming Mode

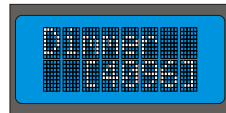
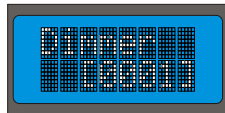
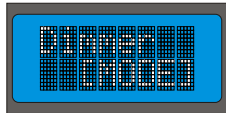

Brightness adjust: 0001-4096 Dimming

### Strobe Mode

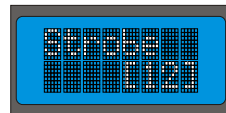
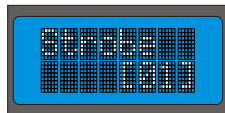
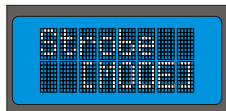

Strobe/Speed : 01-12 Dimming

### Master/Slave Setting:

- 1, Master: Dimming Mode/ Strobe Mode
- 2, All Salves: DMX001 (as below)

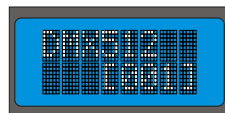

# LED Profile light

## 4.Illumination Diagram

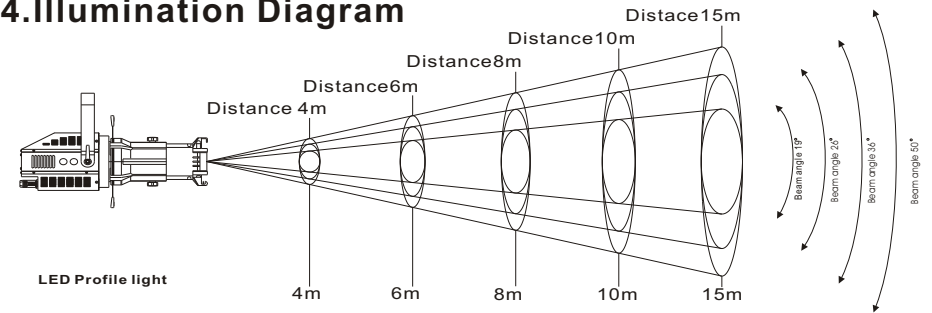

LED Profile light

CCT: 3200K

Illumination Center/Lux	3100	1390	870	680	335	Beam angle 19°
Beam Diameter/cm	124	180	248	315	503	
Illumination Center/Lux	1850	830	698	590	250	Beam angle 26°
Beam Diameter/cm	185	277	370	462	693	
Illumination Center/Lux	1100	756	526	405	192	Beam angle 36°
Beam Diameter/cm	220	380	430	620	900	
Illumination Center/Lux	695	360	203	160	86	Beam angle 50°
Beam Diameter/cm	373	560	746	933	1400	

CCT: 6500K

Illumination Center/Lux	3410	1585	960	756	390	Beam angle 19°
Beam Diameter/cm	124	180	248	315	503	
Illumination Center/Lux	1950	905	786	650	305	Beam angle 26°
Beam Diameter/cm	185	277	370	462	693	
Illumination Center/Lux	1210	840	630	518	240	Beam angle 36°
Beam Diameter/cm	220	380	430	620	900	
Illumination Center/Lux	750	425	290	218	115	Beam angle 50°
Beam Diameter/cm	373	560	746	933	1400	

## 5.Installation



Floor



Hanging

# LED Profile light

## 7. Technical parameters

LED Source	1xWhite200W LED(3200K),CRI>90;(5600K LED is available)
Optical group	Beam angle 19,26(Beam angle 36 , 50 available) with high-efficiency optical system
Control	3 DMX channels;LCD display+4 soft keys;4 selectable dimming curves
Connection	PowerCON In & Out; 3-pole DMX In & Out(5-pole DMX available)
Voltage	Electronic full-range AC 90-260V 50/60Hz
Max Power	200W
Measurements	Size: 58X28X21cm Weight: 8Kg

## 8. Control Panel

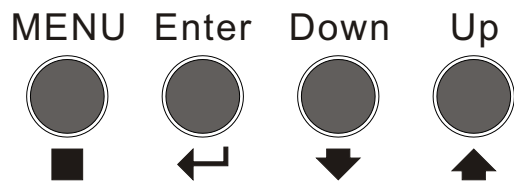
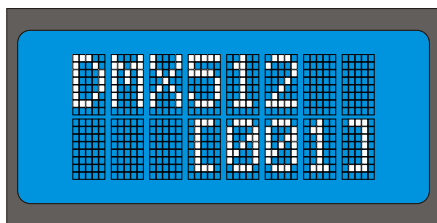

- Adjust keys function on panel
- Press “MENU” --->Display first-level menu--->  
 Press “Enter” --->Display second-level menu--->  
 Press “Down” & “Up” to adjust relevant function--->  
 Press “Enter” and “MENU” to quit current menu--->  
 Press “MENU” --->To next first-level menu...

# LED Profile light

## 9. Menu

